

# ***ACCORD*** ***HYBRID***

## 2018–20 Honda Accord Hybrid Emergency Response Guide

Prepared for Fire Service, Law Enforcement, Emergency Medical, and Professional Towing Personnel

Supersedes 2018–19 Honda Accord Hybrid Emergency Response Guide, dated December 2018. This guide now applies to the 2020 model.

This guide has been prepared to assist emergency response professionals in identifying a 2018–2020 Honda Accord Hybrid vehicle and safely respond to incidents involving this vehicle.

Copies of this guide and other emergency response guides are available for reference or downloading at <https://www.honda.ca/owners/esafety-info>

For questions, please contact Honda Customer Service at 1-888-946-6329.

Honda wishes to thank emergency response professionals for their concern and efforts in protecting Honda customers and the general public.



## Contents

Vehicle Identification.....4

Vehicle Dimensions.....6

Vehicle Description.....7

Component Location.....11

Potential Hazards.....13

Vehicle Collision.....14

Emergency Procedures.....15

Emergency Procedures **High-Voltage Shut Down Procedure**.....16

Emergency Procedures **Extricating Occupants**.....19

Emergency Towing.....20

Vehicle Repairs.....22



**ACCORD**

**HYBRID**



The Honda Accord Hybrid can be identified by the emblem **ACCORD**, mounted on the trunk and the **HYBRID** emblem mounted on the trunk and the front fenders.

A Honda Accord Hybrid can also be identified by inspecting the VIN at the three locations shown below.

Characters 4–6 of the VIN will show **CV3** indicating that it is a Honda Accord Hybrid.

1HGCV3\*\*\*\*\*000001



VIN plate located on the lower-right corner of the front windshield.



Stamped into the floor panel in front of the passenger seat under a plastic panel marked **FRAME NUMBER**



Printed on the VIN label on the driver's doorjamb.

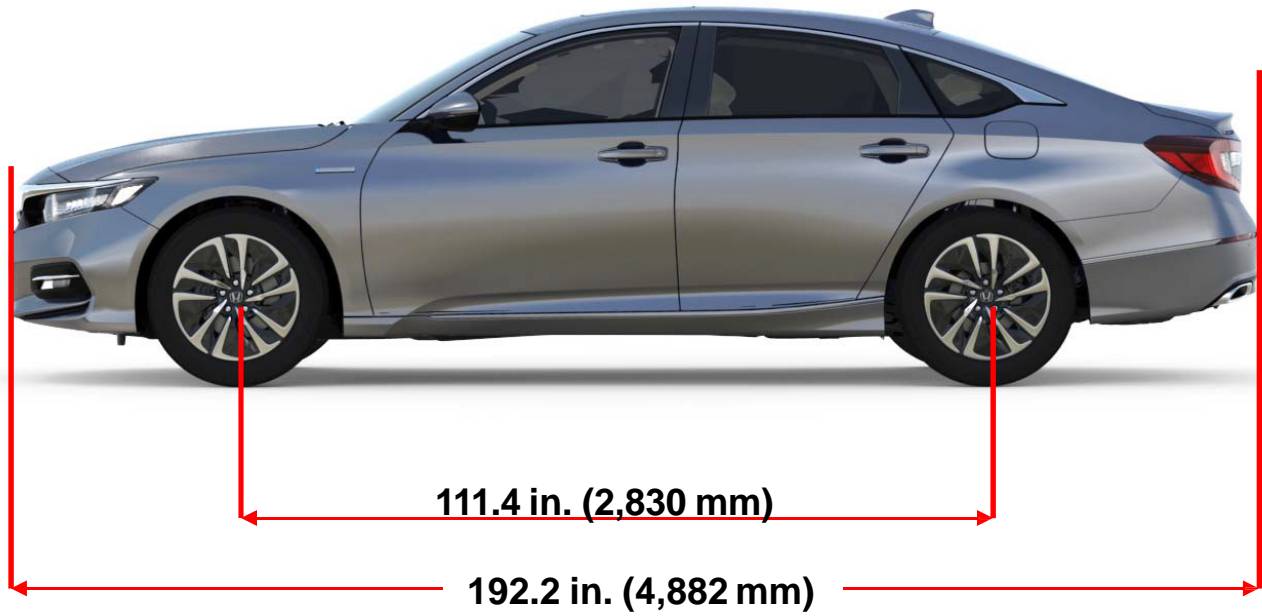

**Vehicle Weight = 4,519 lb. ( 2,050 kg)**

## High-Strength and Ultra-High-Strength Steel

The body of the Honda Accord Hybrid is made of high-strength steel and ultra-high-strength steel indicated in the colored areas.

Upper View

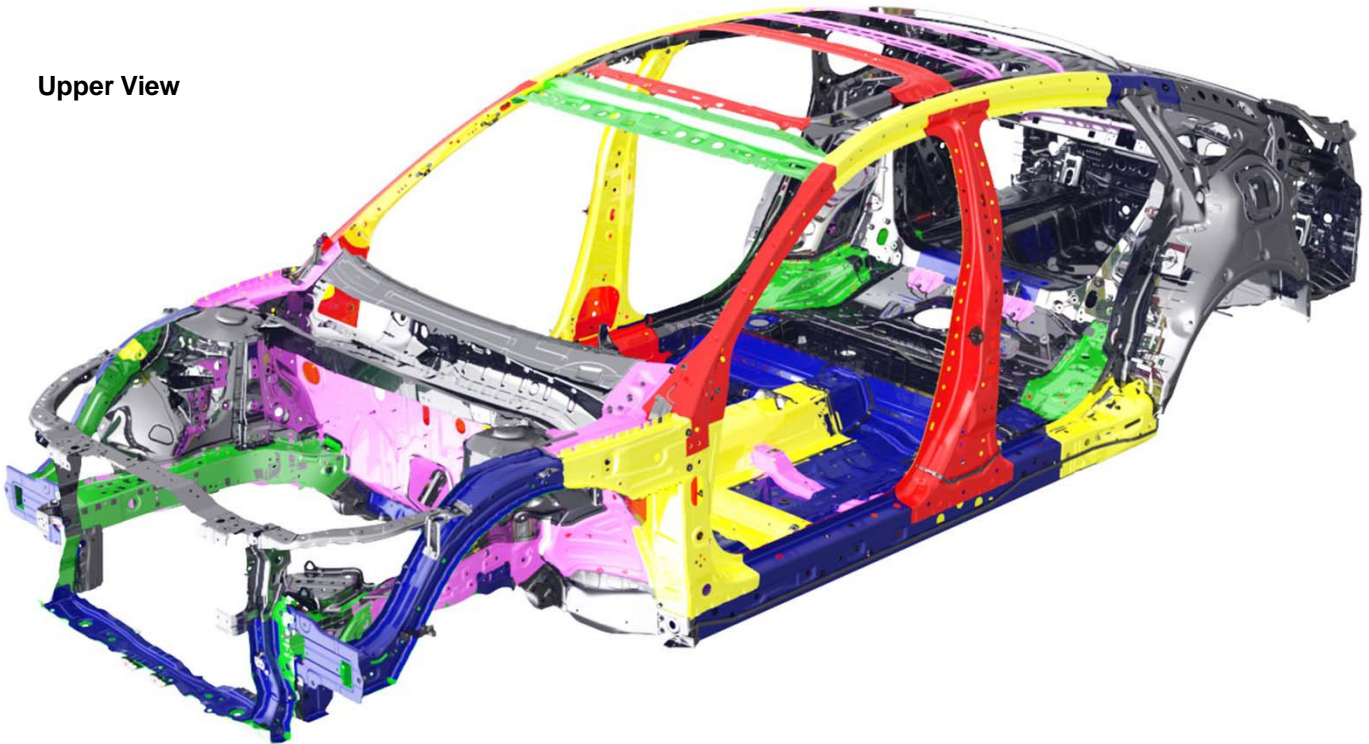

Lower View

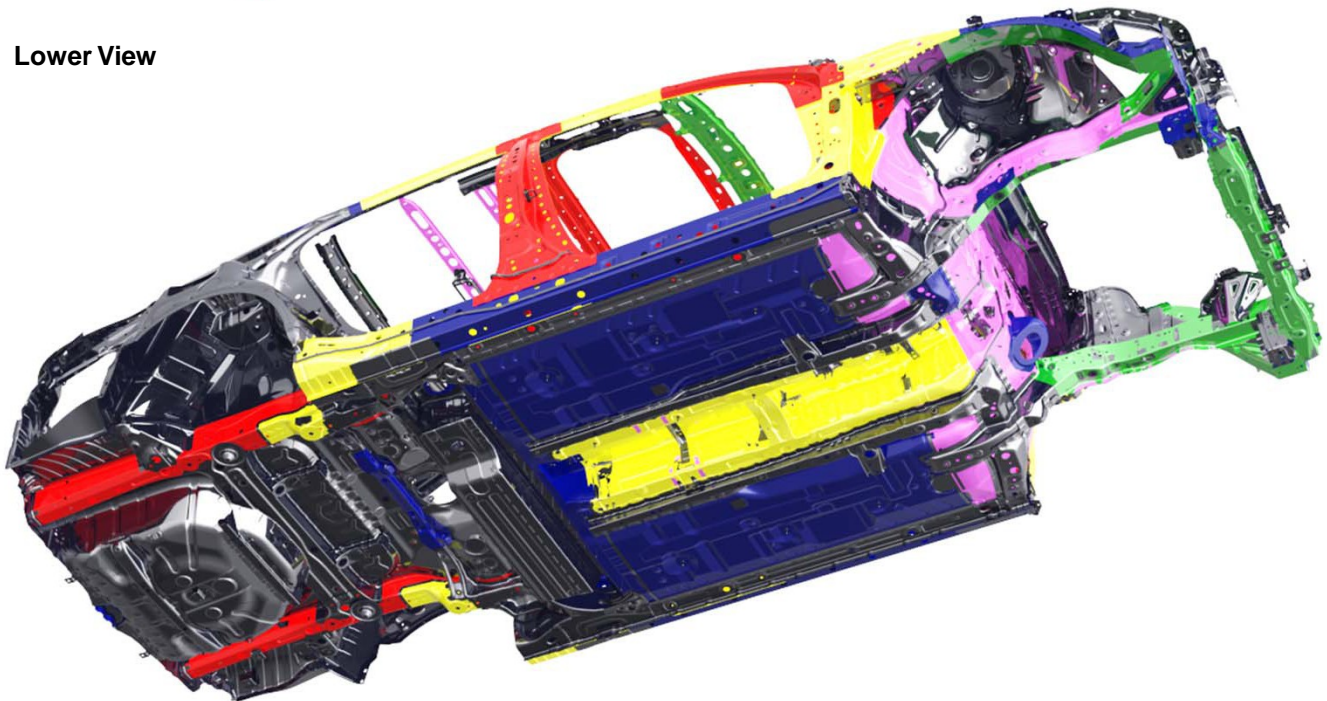

### Exterior Body Parts

Except for the aluminum hood, the exterior body parts are made of high-strength steel and ultra-high-strength steel indicated in the colored areas.

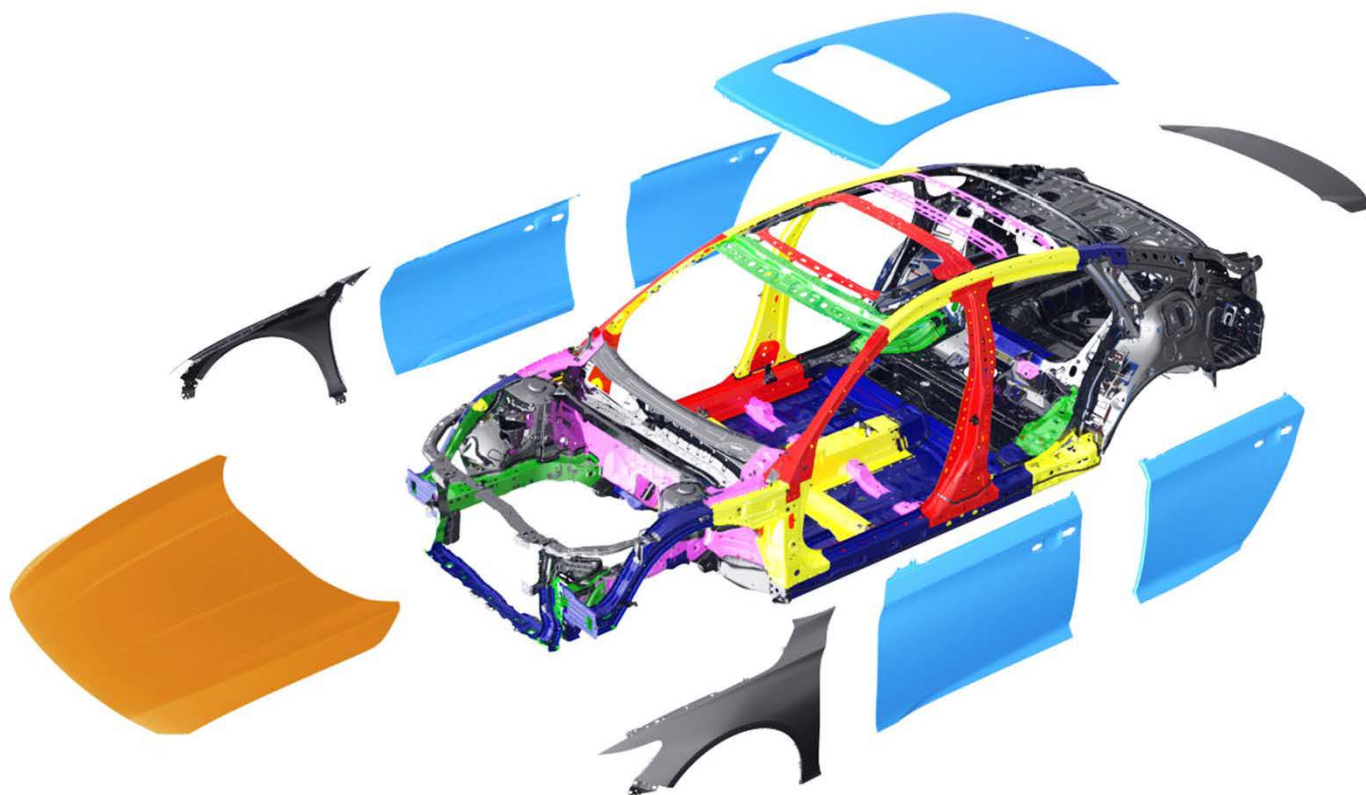



## Seat Belts and Airbags

The Honda Accord Hybrid is equipped with lap/shoulder belts in all seating positions. The front seat belts are equipped with pyrotechnically activated tensioners that help tighten the seat belt in a sufficient crash.

In addition, the Honda Accord Hybrid is equipped with the following airbags:

- Front Airbags - Driver/Front Passenger
- Side Airbags - Driver/Front Passenger
- Side Curtain Airbags – Driver’s Side/Passenger Side (Both Rows)
- Knee Airbag – Driver/Front Passenger

In a collision severe enough to deploy one or more of the airbags, the Honda Accord Hybrid electrical system is designed to automatically open the high-voltage electrical contactors. This disconnects the high-voltage battery from the other high-voltage components and stops the flow of electricity in the high-voltage cables.

**Responders should always assume, however, that the high-voltage system is powered on and take the appropriate action described later in this guide to power off the system.**

It takes up to 3 minutes for the airbags and tensioners to power off after the 12-volt system has been turned off by following the emergency shutdown procedures provided later in this guide.

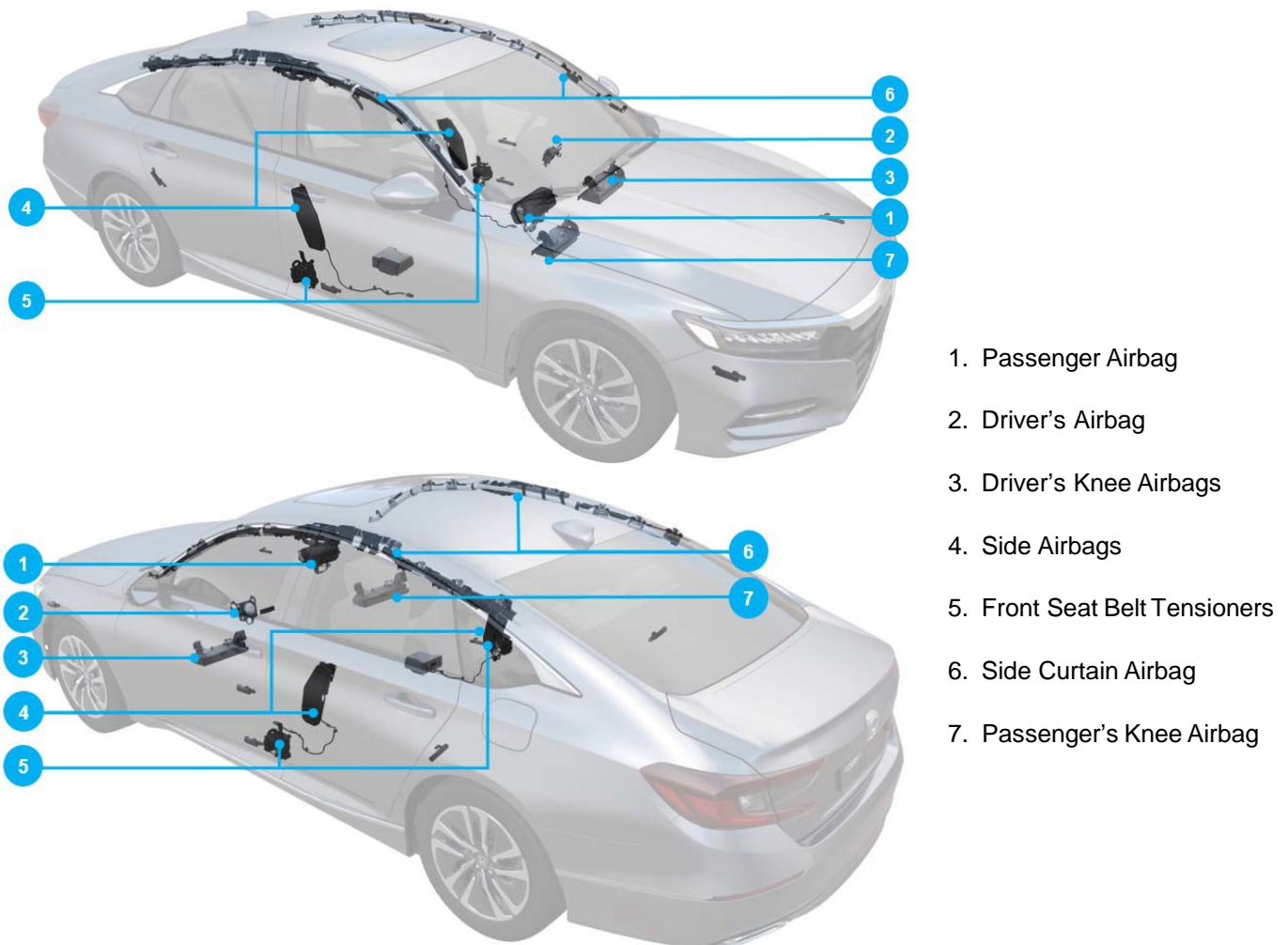

## 12-Volt Battery

A conventional 12-volt battery is located under the front hood of the vehicle. This battery powers the airbags, lights, audio system, and other standard 12-volt system components. In an emergency situation, it may be necessary to disconnect or cut the 12-volt battery negative cable.

## High-Voltage Lithium-Ion Battery

In addition to a 12-volt battery, the Honda Accord Hybrid has a high-voltage lithium-ion battery located in a well-protected area below the rear seat. This means that the lithium-ion battery body is normally hidden from view. The battery pack is made up of 72 cells, totaling approximately 259.2 volts.

The battery electrolyte is sealed inside the lithium-ion battery. In the unlikely event that the lithium-ion battery is damaged, there is no danger of electrolyte liquid pouring out in large quantities.

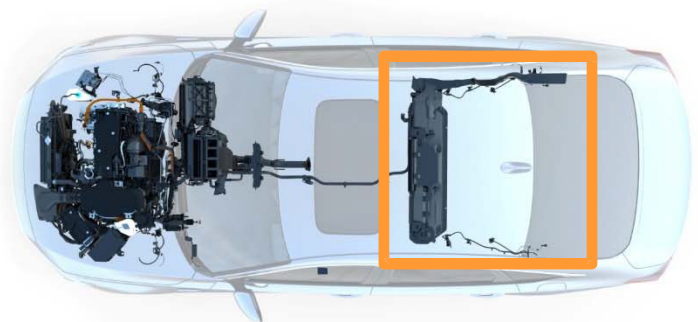
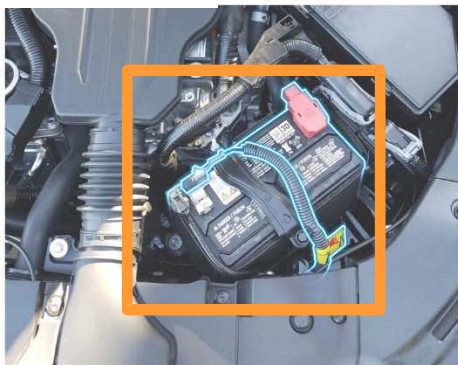

**High-Voltage Components**

**High-Voltage Lithium-Ion Battery**

**Electric Drive Motor**

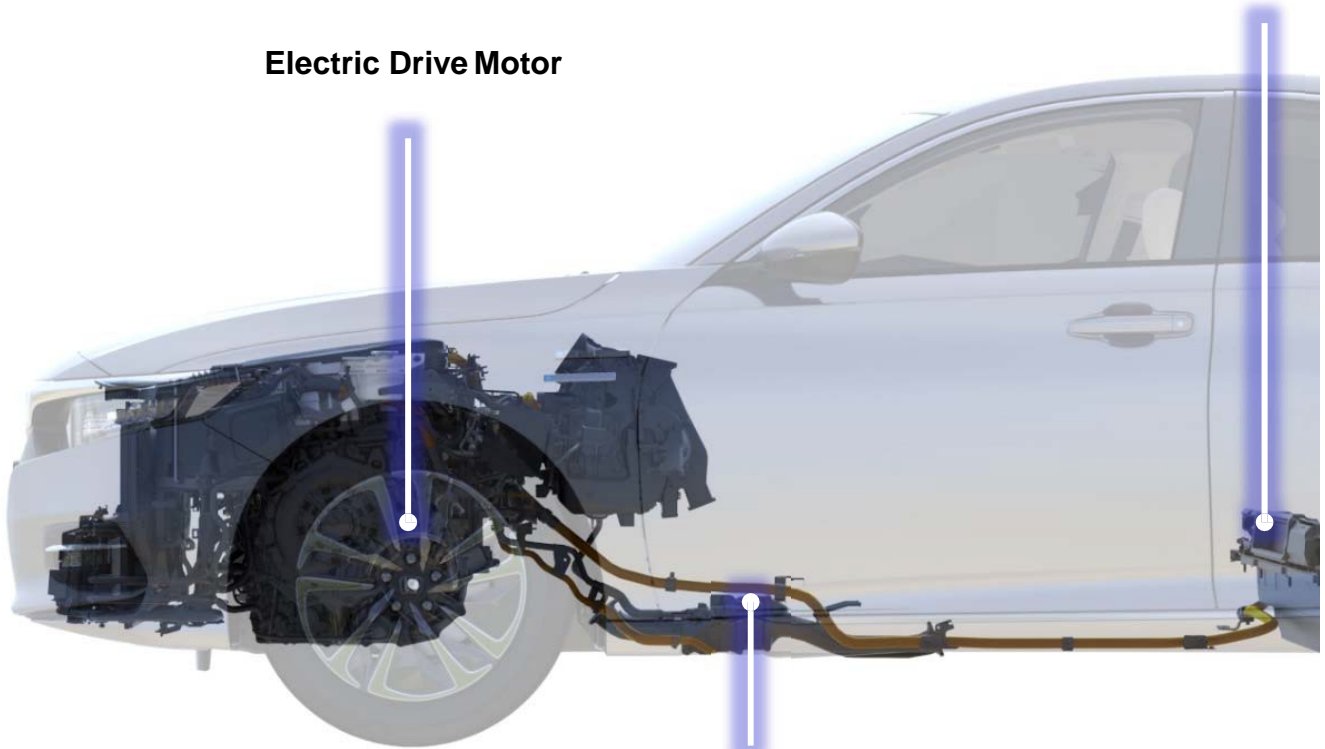

**High-Voltage Cables**

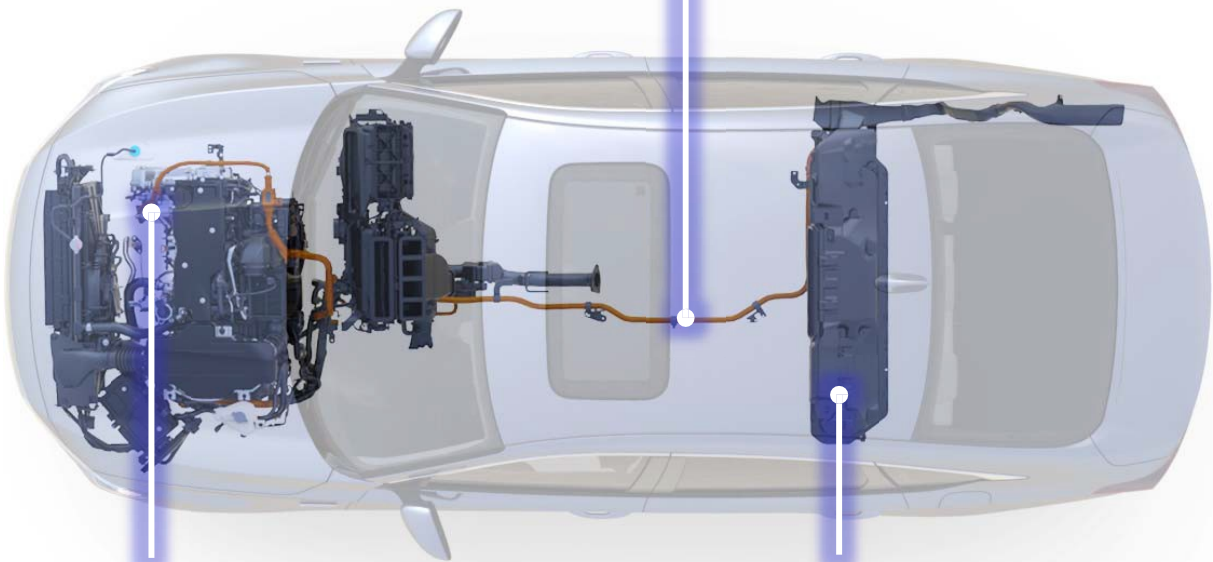

**High-Voltage Air Conditioning  
Compressor**

**High-Voltage Lithium-Ion Battery**

## Key Components

High voltage flows through easy-to-identify, heavy-duty orange cables. These cables are purposely routed through areas away from the usual cut points.

There is a section of the engine room harness and the 12-volt battery cable that can be cut in the event of emergency and the high-voltage system needs to be shut down. They can be identified by the labels as shown.

### High-Voltage Cables

### Fuse Box

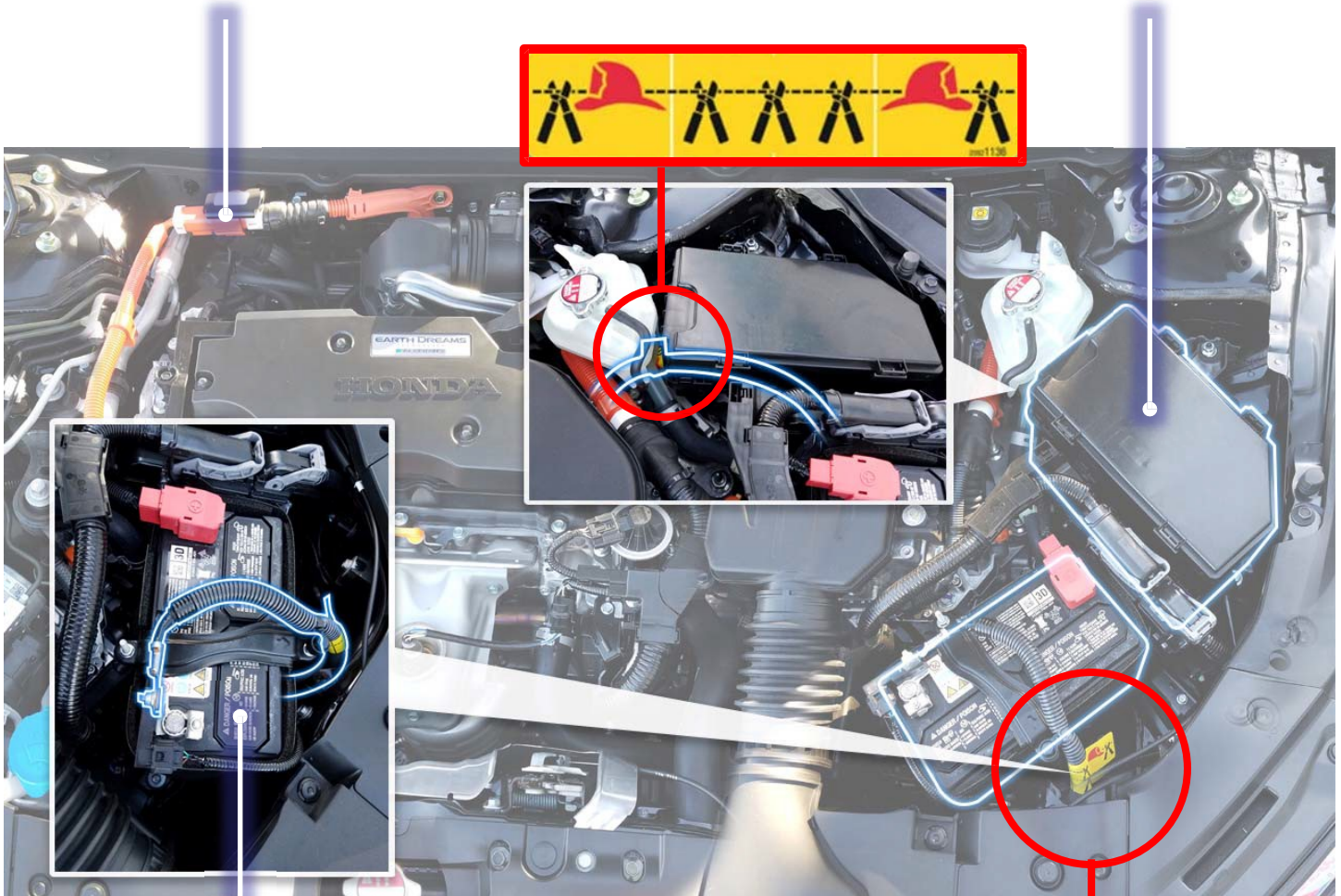

12-Volt Battery

**Cut Point Labels**  
(Refer to page 19 for more information.)

### Lithium-Ion Battery Fumes or Fire

A damaged high-voltage lithium-ion battery can emit toxic fumes and the organic solvent used as electrolyte is flammable and corrosive, so responders should wear appropriate personal protective equipment. Even after a lithium-ion battery fire appears to have been extinguished, a renewed or delayed fire can occur. The battery manufacturer cautions responders that extinguishing a lithium-ion battery fire will take a large and sustained volume of water.

***Responders should always ensure that a Honda Accord Hybrid with a damaged battery is kept outdoors and far away from other flammable objects in order to minimize the possibility of collateral fire damage should the battery catch on fire.***



### Lithium-Ion Battery Fluid

Avoid contact with the high-voltage battery fluid. The high-voltage battery contains a flammable electrolyte that could leak as a result of a severe crash. Avoid any skin or eye contact with the electrolyte as it is corrosive. If you accidentally touch it, flush your eyes or skin with a large quantity of water for at least 5 minutes and seek medical attention immediately.

### Electric Shock

Unprotected contact with any electrically charged high-voltage component can cause serious injury or death. Receiving an electric shock from a Honda Accord Hybrid, however, is highly unlikely because of the following:

- Contact with the battery module or other high-voltage components can only occur if they are damaged and the contents are exposed, or if they are accessed without following proper precautions.
- Contact with the electric motor can only occur after one or more components are removed.
- The high-voltage cables can be easily identified by their distinctive orange color, and contact with them can be avoided.

***If severe damage causes high-voltage components to become exposed, responders should take appropriate precautions and wear appropriate insulated personal protective equipment.***



In the event of a crash, the SRS (supplemental restraint system ) unit makes a judgment based on input from the impact sensors. If the input values meet various threshold requirements, the SRS unit sends a signal to the high-voltage battery ECU (electronic control unit). The high-voltage battery ECU then turns off the high-voltage battery contactors, stopping the flow of electrical current from the high-voltage battery.

When responding to an incident involving a Honda Accord Hybrid, we recommend that emergency personnel follow their organization's standard operating procedures for assessing and dealing with vehicle emergencies.

Given our knowledge of the Honda Accord Hybrid, we also recommend that responders follow the procedures on the following pages to avoid potentially lethal shock by high voltage.



**Submerged Vehicle**

If a Honda Accord Hybrid is submerged or partly submerged in water, first pull the vehicle out of the water. Then, shut down the high-voltage system using one of the two procedures described on the following pages.

Aside from severe damage to the vehicle, there is no risk of an electric shock from touching the vehicle's body or framework — in or out of the water. If the high-voltage battery was submerged, you may hear noises from the battery as the cells are being discharged from shorting.



## Preventing Current Flow Through High-Voltage Cables

Before attempting to rescue occupants or move a damaged Honda Accord Hybrid, you should reduce the potential for current to flow from the electric motor or the high-voltage battery through the high-voltage cables.

There are **two recommended methods** for preventing current flow. These are discussed on the following pages.

### **BEST METHOD for High-Voltage Shutdown**

**Push and hold the POWER button for 3 seconds.**

This simple action turns off the vehicle and immediately shuts down the high-voltage system controllers, thereby preventing current flow into the cables. It also cuts power to the airbags and the front seat belt tensioners, though these pyrotechnic devices have up to a 3-minute deactivation time.

To prevent accidental restarting, you must remove the keyless remote from the vehicle and move it at least 20 feet away.

If you cannot locate the keyless remote, you should also do the SECOND-BEST METHOD for High-Voltage Shutdown (for preventing high-voltage current flow) on the following page.

**Push and Hold = 3 Sec.**





**SECOND-BEST METHOD for High-Voltage Shutdown**

Locate and cut the negative 12-volt battery cable and the DC to DC converter cable.

Together, cutting the negative 12-volt battery cable and the DC to DC converter cable immediately turns off and shuts down the high-voltage system controllers and the engine, thereby preventing current flow into the high-voltage cables.

1. Pull the hood release handle located on the driver's left kick panel.

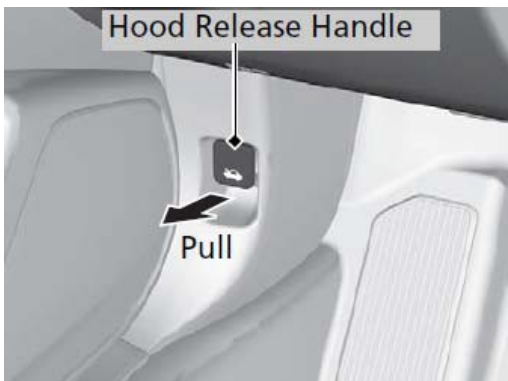

2. Push the hood latch lever (located under the front edge of the hood to the center), and raise the hood. Once you have raised the hood slightly, you can release the lever.

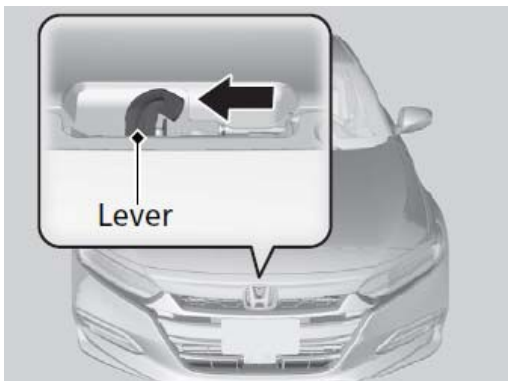

3. Remove the support rod from the clamp using the grip. Mount the support rod in the hood.

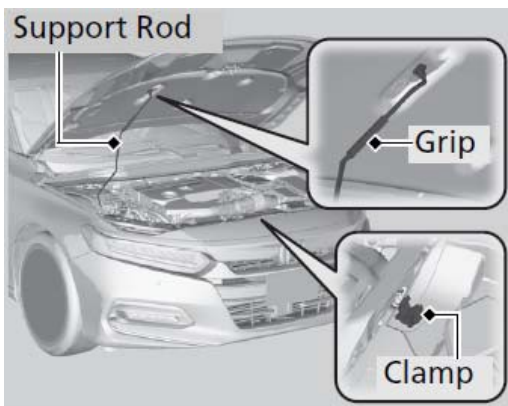

Continue to the next page.

**SECOND-BEST METHOD for High Voltage Shutdown**

4. Locate the two cut point labels as shown, and cut them.

*When cutting the cables, do not allow the cutting tool to contact any surrounding metal parts; electrical arcing could occur, which can ignite any flammable vapors.*

**NOTE:** If you cannot do either method to stop the engine and prevent current flow into the high-voltage cables, use extreme care and do not touch damaged cables as they may be electrically charged.

**High-Voltage Cables**

**Fuse Box**

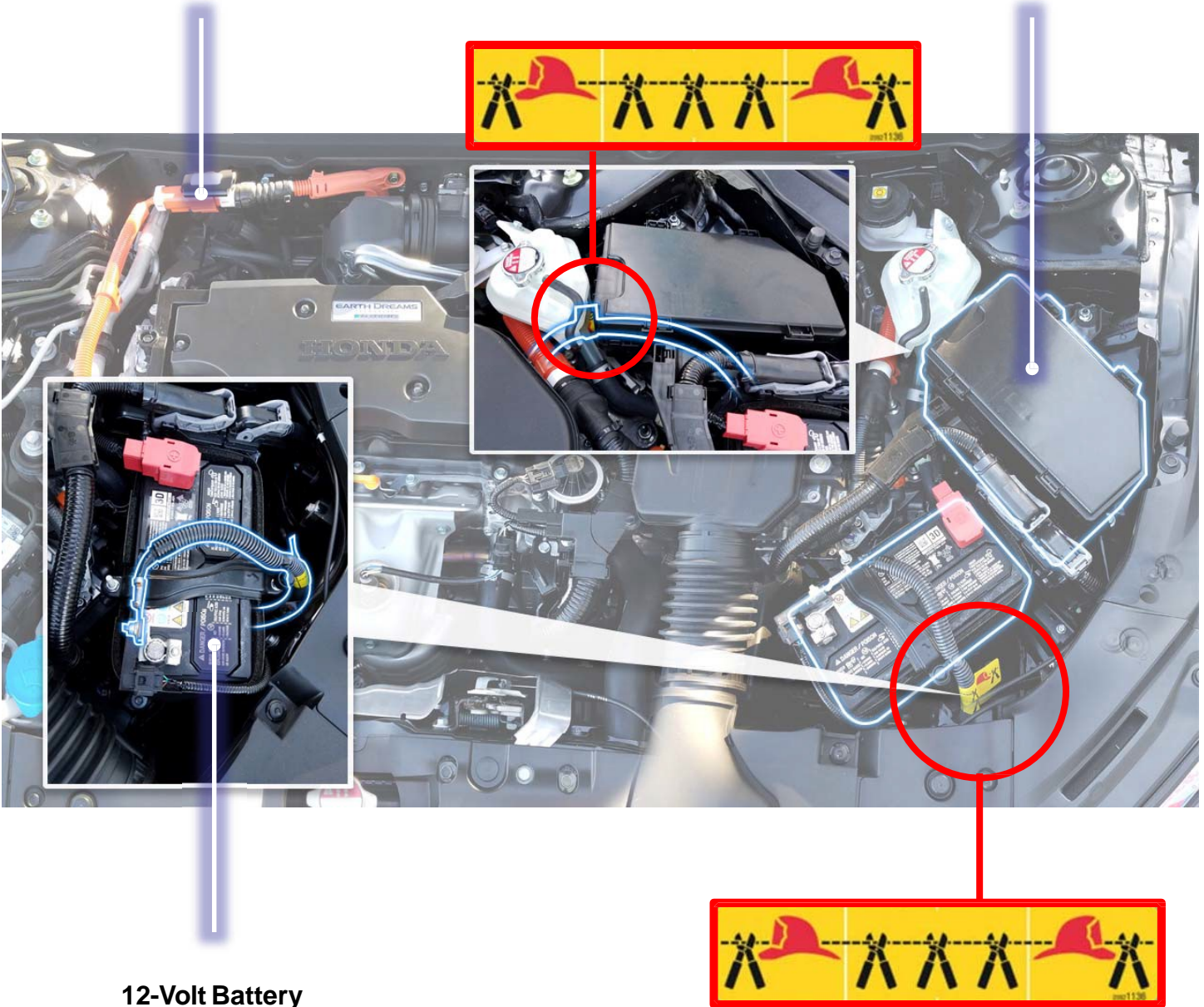

**12-Volt Battery**

**Extricating Occupants**

If you need to cut the vehicle body or use Jaws-of-Life equipment to remove occupants, be sure to stay within the cut zone as shown.

Side Curtain Airbag Inflator



If you need to cut the hood to open it, be sure to stay within the cut zone as shown.



**Emergency Towing**

The preferred method for emergency towing is to use a flat-bed tow truck. If wheel lift equipment must be used, be sure to suspend the front wheels and release the parking brake.

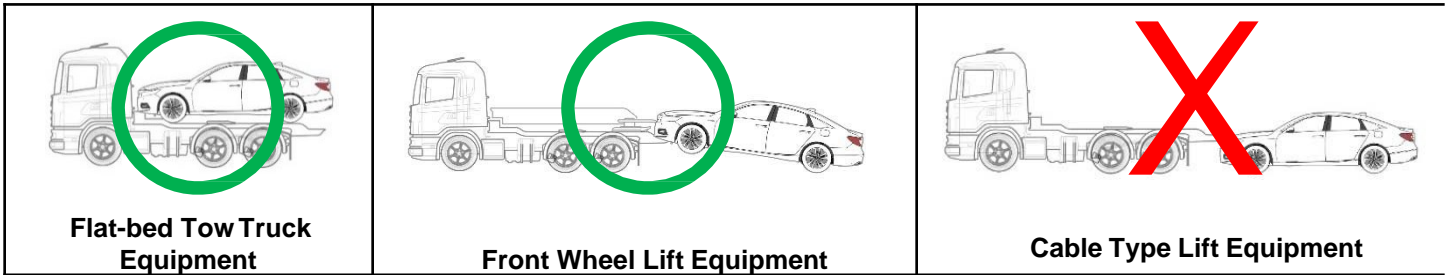

Be aware that when rolling a Honda Accord Hybrid with the front (drive) wheels on the ground, the electric motor can produce electricity and remains a potential source of electric shock even when the high-voltage system is turned off.

**Warning**

If orange high-voltage cables or high-voltage covers have been damaged, exposing wiring, terminals, or other components, the exposed parts should never be touched. Doing so could result in serious injury or death due to severe burns or electric shock.

If it is not clear whether the exposed wires and terminals are high-voltage components or not, do not touch them.

If touching high-voltage cables and other high-voltage components is unavoidable, personal insulating protective equipment (insulating gloves, protective goggles, and insulating boots) should always be worn.

## Securing the Vehicle

The recommended tie-down locations for securing the vehicle are indicated in red.

- Two tie-down slots are located behind the front wheels and in front of the rear wheels.
- The front tow hook is located in front of the right-front tire.
- There is no tow hook at the rear.

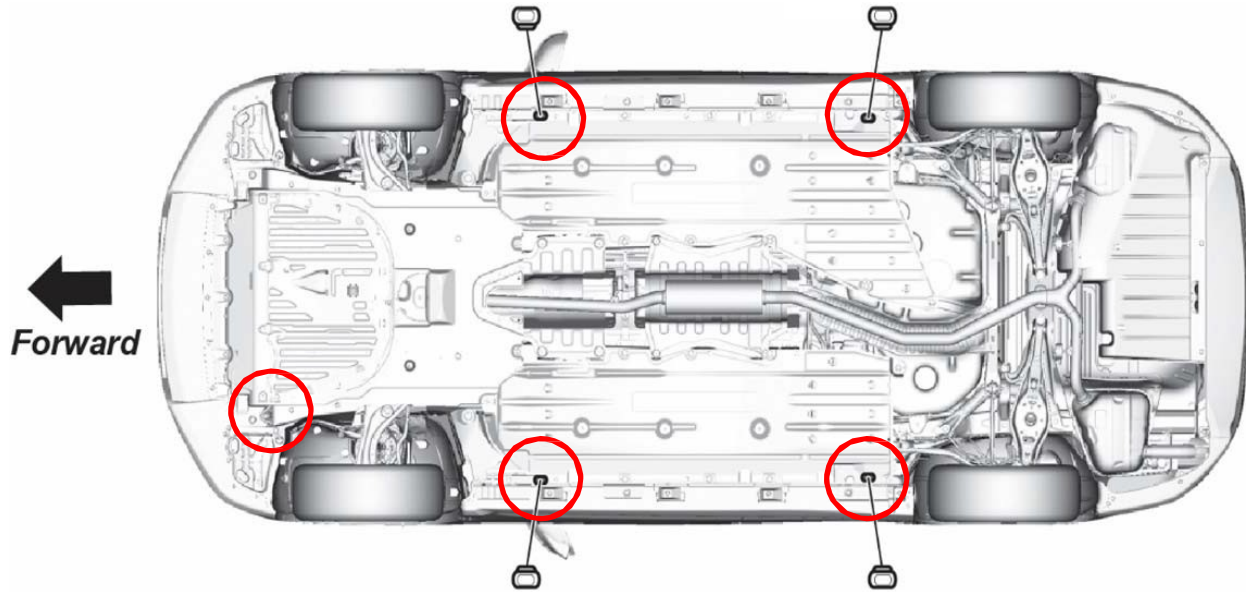

## Acoustic Vehicle Alerting System

The Honda Accord Hybrid is equipped with an acoustic vehicle alerting system and alerts pedestrians that it is approaching with an audible sound when the speed is about 12 mph or less. When pushing the Honda Accord Hybrid with the vehicle in the ON mode, you will hear this sound as the vehicle is being moved.

**Dealer Inspection and Repair**

A damaged Honda Accord Hybrid should be taken to an authorized Honda dealer for a thorough inspection and repairs. For questions or to locate an authorized Honda dealer, please contact Honda Customer Service at 1-888-946-6329.

**High-Voltage Battery Recycling**

The high-voltage lithium-ion battery requires special handling and disposal. If disposal is necessary, please contact Honda Customer Service at 1-888-946-6329 for assistance.

